

TSM2500 Series High Efficiency Intelligent Charger

ThunderStruck User Manual Ver. 1.05



Table Of Contents

I. Product Overview

II. Safety

III. Preventing Leakage and Fire

1. Correct use of Breakers, Sockets and Cables

2. Correct Use of Input Connections

3. Charging Environment Requirements

IV. Regular Maintenance

V. Technical Specifications

VI. Parts List

VII. LED Charge Light Information

VIII. Appearance and Installation Dimensions

IX. Connections and Wiring

X. Faults & Solutions

I Product Overview

The TSM2500 series high efficiency intelligent charger is designed to charge traction batteries of electric vehicles. This series of products adopt the most advanced technologies such as LLC resonant, active power factor correction, microcomputer measurement and control, digital adjusting, and extremely water resistant technology. Its features include: wide input voltage range, high input power factor that significantly reduces the input current as well as heat generated from the input cable, and Low harmonic current that reduces interference to other electric equipment. Full range soft switching is used to achieve high conversion efficiency and very little electromagnetic interference. The charger is designed according to IP66 protection grade and is highly water resistant. It is also small in size, lightweight, quiet, beautiful, simple to install and of course easy operation and maintenance.

The charger uses microcomputer measurements and control technology, the embedded CPU can accurately detect battery voltage and charge current.

The charger has temperature compensation functions, as well as automatic shut down after being fully charged. Reverse battery connection protection as well as output short circuit protection, AC input under voltage protection, and overheating protection . These functions help to ensure safe and reliable use.

II Safety

1. Please do not disassemble the charger; this may cause electric shock or other injuries.
2. If the charger needs to be connected to an AC power supply with extension cables, please make sure that the extension cable can withstand the maximum input current (GB 2.5mm² copper core cable is recommended to be used), and limit the extension cable length within 10m.
3. Don't place the charger where it can get wet, this may cause damage to the charger as well as electric shock to the operator.
4. The charger's DC output plug should be connected reliably to the socket, if they are damaged or loose, please replace them immediately, otherwise it will cause overheating in the plug position, and can even cause fire.
5. If the charger produces any abnormal sound or smell while on, please unplug the power immediately and contact the service department. Do not attempt to open the charger case.
6. Make sure that all air vents are unobstructed to prevent charger overheating. Do not place the charger near a heat source; the charger should be left with enough space to ensure proper ventilation.
7. Please disconnect the charger's AC input power if you need to move it.
8. Make sure that AC power supply voltage matches chargers' input voltage. For inquiries, please contact your supplier or local power Supply Corporation.
9. Battery voltage and the nominal voltage of the charger must be matched or it could damage both the charger and the batteries.
10. To avoid damage to the charger's cables, do not pull, twist or shake the cables or the connection terminals. If the cable is worn, please replace it immediately.

III Preventing Leakage and Fire

1. Correct use of Breakers, Sockets and Cables

1. Use copper core cables with flame-retardant jackets. The cables' core diameter must be at least 2.5mm in diameter.
2. Prevent plugs, sockets from coming in contact with water.

Note: According to statistics, 80% of electric car fires occur during charging. The main reasons for this include insufficient core diameter, size of cables, poor quality plugs and sockets, poor contact of plugs and sockets, poor flame-retardant sheath or shells of breakers, plugs and sockets and so on.

2. Correct Use of Input Connections

Make sure that the plug is clean, undamaged and free of dirt before charging.

3. Charging Environment Requirements

Have it be spacious and away from flammable materials. Avoid mounting/placing the charging plugs, charging cables or the charger itself on car cabs, synthetic seats and other flammable objects.

4. Lithium Safety

A lithium battery pack should have a battery management system to ensure safe charging. A battery pack with no BMS can be a very dangerous thing. We are not responsible for damage to batteries due to using a charger with no BMS.

Most prismatic lithium batteries should be contained in a manner that prevents them from swelling during charging and discharging. Consult your battery manufacturer's recommendation for the best way to package your cells.

IV Regular Maintenance

1. Check the J1772 Socket regularly for corrosion or other conduction inhibitors. Poor contact may result in overheating and burning inside the socket, which although unlikely could cause fire.
2. Make sure to use a charger that has a dedicated breaker and wire running to it.
3. Make sure that the charger's shell and cooling fan are free of debris and dirt.

V Technical Specifications

Rated input voltage: 220VAC 50/60Hz

Input voltage range: 85~265VAC (Note: When the Input voltage is lower than 185VAC, the output power will be limited to 1.5KW)

Power Factor: ≥ 0.99 @ 220VAC input, full power output;

Total Harmonic Current: $\leq 5\%$ @ 220VAC input, full power output;

Nominal output voltage: 144V

Maxim output voltage: 180V

Rated output current: 15A

Voltage regulation accuracy: $\leq 0.5\%$

Current regulation accuracy: $\leq 2\%$

Conversion efficiency: $\geq 95\%$ @ 220VAC input, full power output

Protection class: IP66

Audible Noise: ≤ 40 dB

Seismic rating: Designed according to IEC60335-2-29-2004-Part.21

Working temperature: $-25\sim 55^{\circ}\text{C}$ (Note: models whose output power greater than 2KW

Storage temperature: $-40\sim 80^{\circ}\text{C}$

Recognition certificates: CE SGS will ensure 2KW output at 60°C .)

VI Parts List

A - AC Input Cables

B - DC Output Cables

C - Signal Cables

D - Charging Indicator E Mounting plate F Shell

G - Cooling Fan and Fan Cover

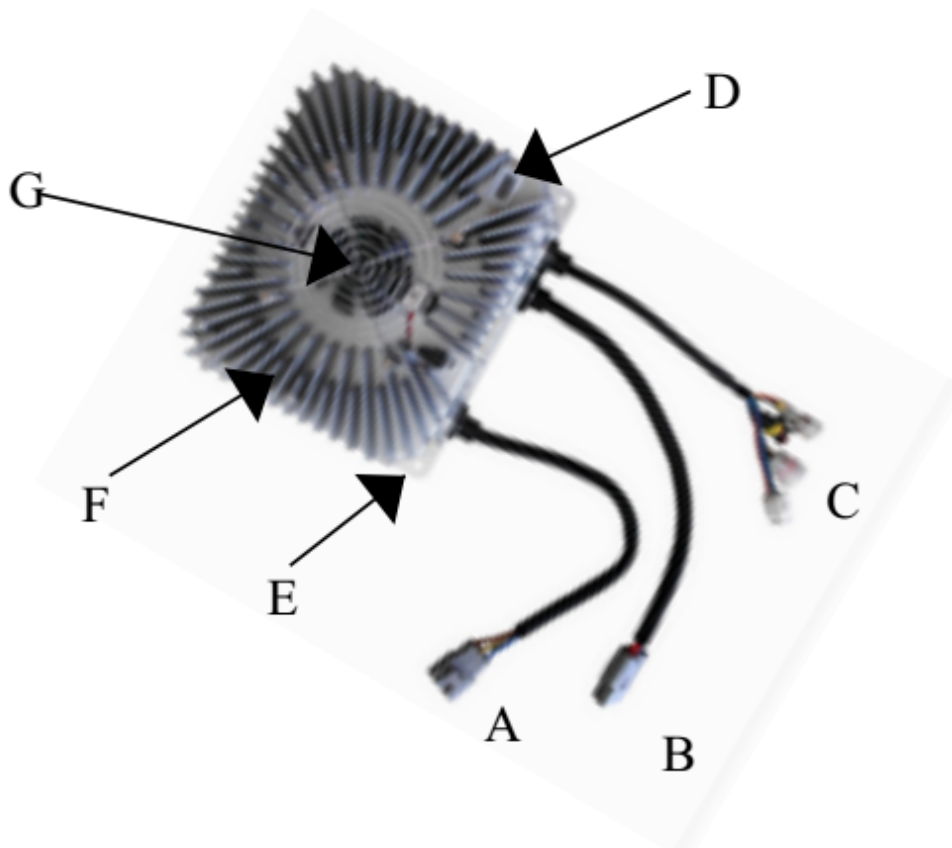

VII LED Charge Light Information

When...	Then...
Green Light Flashing	It is Charging Normally
Flashing Yellow, Red and Green in Various Orders	Charging has recently stopped or has a Fault with Charger or Batteries. Contact Thunderstruck-ev.com .

VIII Appearance and Installation Dimensions

Do not bend the wires coming out of the charger until they have at least 50mm of space from where they enter the shell of the charger.

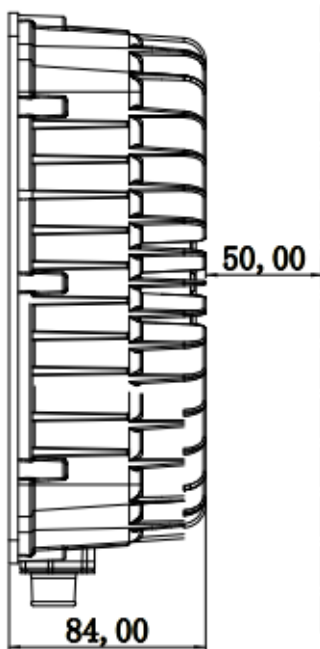
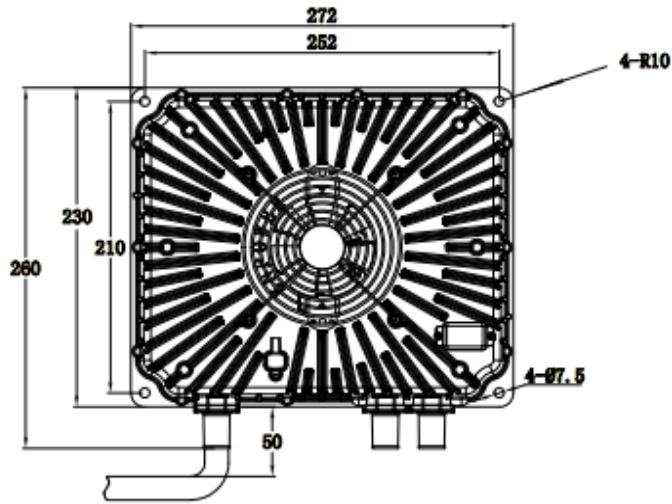

Insure that there is a 50mm gap above the charger to allow for proper ventilation.

IX Connections and Wiring

Input Cables

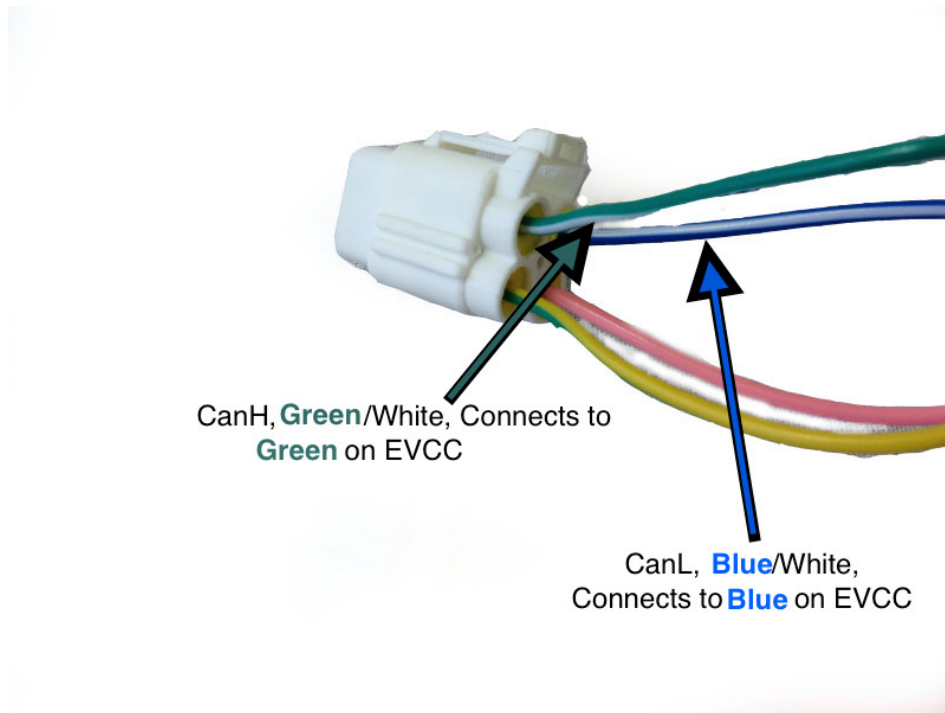

Note Above: The Yellow and Pink wires are not used, Refer to the EVCC Manual for more details on EVCC wiring.

For 110V

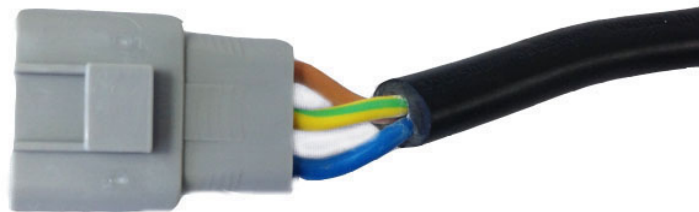

Yellow/Green - Ground Wire

Blue - Neutral Wire

Brown - Live Wire

For 220V

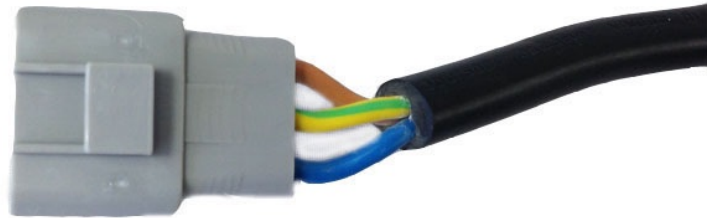

Yellow/Green - Ground Wire

Blue - Live Wire

Brown - Live Wire

Output Cables

Red - Positive DC Out

Black - Negative DC Out

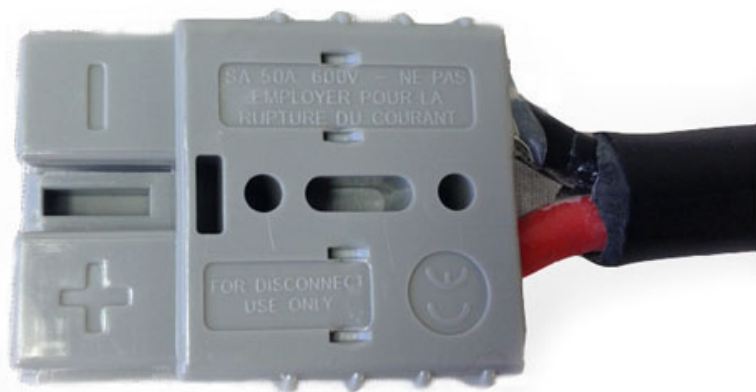

SB50 Connector

X Faults and Solutions

If your charger is not working correctly, you can refer to the table below:

Fault	Analysis	Solutions
Battery temperature Sensor Fault	External battery temperature sensor is fault or not connected	Check sensor connection or change a new one
Battery not connected	Battery is not connected or reverse connected	Check and connect the battery correctly
Over-Temperature Protection	Charging environment temperature is too high; cooling fan is fault; air vents are obstructed	Place the charger in lower temperature environments and retry; Check whether cooling fan is at fault or air vents are obstructed
Input fault protection	Poor contact of charger's input side; Charger is broken	If no poor contact phenomenon occurs, please contact us
Charging timeout	Battery is damaged or aging	Check and replace battery
Battery Overheating	Battery is damaged or aging	Check and replace battery
Internal temperature Sensor fault	Charger is broken inside	Please contact us
Output voltage Feedback fault	Charger is broken inside	Please contact us
"Full Power "after Short charging	Battery is broken; Poor contact between charger and battery; Battery has been fully charged;	Check whether the battery is damaged; battery connecting cables are firm ; the battery is fully charged
Battery temperature becomes more than 50°C	Battery is aging; Battery voltage is lower than the nominal voltage of the charger	Check the battery, and replace bad battery; Reselect charger that match battery voltage level .
Low battery capacity after full charge	Battery is aging	Replace the battery
	Cables are too long or too thin Between the charger and battery	Reduce the output cables back to initial length
Charging time becomes too short or too long	Battery is aging	Replace the battery
	Charger overheating protection	Check if there are foreign matters around the fan and remove them Check whether the cooling fan is working correctly, or contact us to replace the fan.

LED indicator lights but no charging	Connectors are not connected firmly, or the polarity is reversed; Battery is disconnected	Connect all connectors correctly and recharge
	Battery is broken	Replace your battery with a new battery
LED indicator doesn't light	AC input is not connected firmly	Check AC power supply and chargers' input cables
	Charger is broken inside	Please contact us

If your charger still does not work correctly after referencing the above list, please record the state of the fault and charge indicator information, then contact us.